

REV.	QTY	C O N T E N T S			DATE	DRAWN	APPROVED

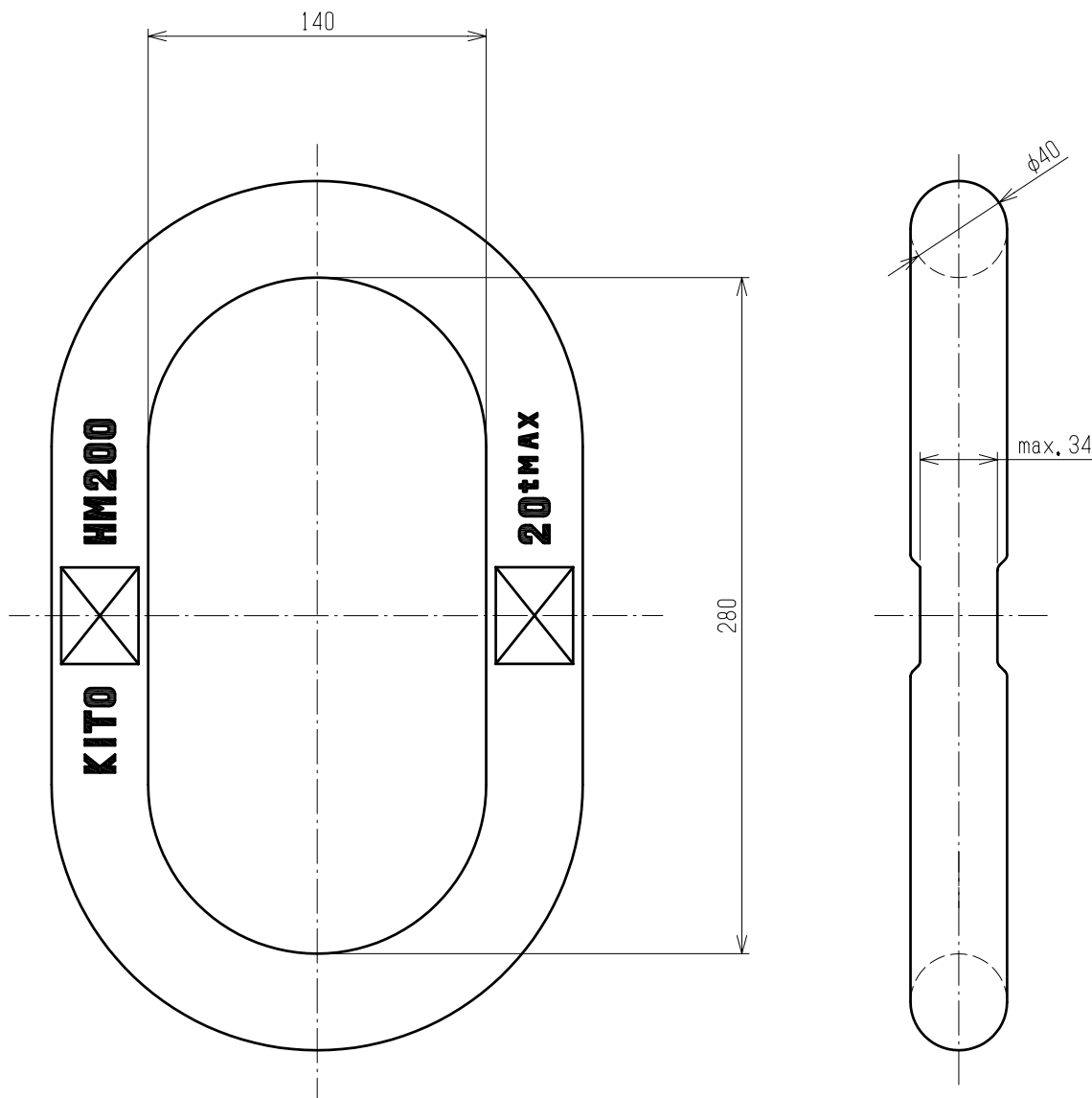

APPROVED	CHECKED	DESIGNED	DRAWN	TITLE			
T. Hatano	A. Naito	T. Ozawa	T. Ozawa	Master Link マスターリンクHM			
2013. 05. 17	2013. 05. 17	2013. 05. 17	2013. 05. 17	CODE	HM200	SCALE	1:3
KITO				DWG. NO.	P1HM200-91043Z	REV.	0