

REV.	QTY	C O N T E N T S			DATE	DRAWN	APPROVED

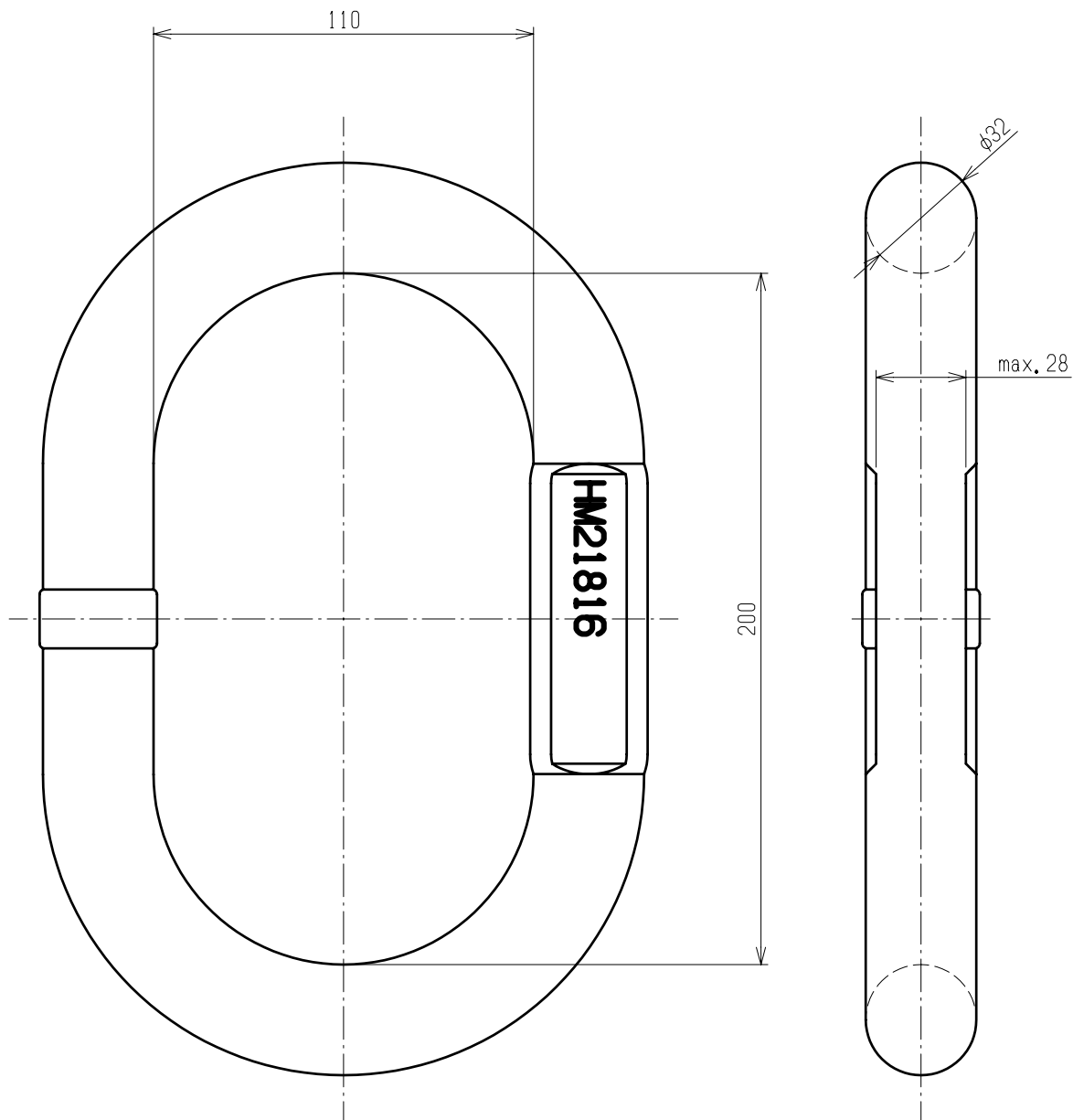

APPROVED	CHECKED	DESIGNED	DRAWN	TITLE			
T. Hatano	A. Naito	T. Ozawa	T. Ozawa	Master Link マスターリンクHM			
2013. 05. 17	2013. 05. 17	2013. 05. 17	2013. 05. 17	CODE	HM21816	SCALE	1:2
<b>KITO</b>				DWG. NO.	P3HM180-91331Z	REV.	0